



RAJASTHAN STATE MINES & MINERALS LTD.

(A Government of Rajasthan Enterprise)

Purchase Department, Phosphate Division, SBU & PC Rock Phosphate,
Jhamarkotra Mines, P.O.: Jhamarkotra, Via. & Dist. Udaipur (Rajasthan)

Phone: 0294-2324441-43 Telefax: 0294-2342444

Website: www.rsmm.com, email: satishkachhawa.rsmml@rajasthan.gov.in, Mob: 9413300435

TENDER SCHEDULE

TENDER DESCRIPTION	FABRICATED NATURE OF ITEMS
TENDER No. & Date	NIT-44/18-19 dated: 05.02.2019
Type of Tender	Two Bid System
Place of Sale	Office of SM (F&A), Marketing Department, Corporate Office, 4 Meera Marg, Udaipur
Submission of Tender Document	Office of SM (F&A), Marketing Department, Corporate Office, 4 Meera Marg, Udaipur
Date of Sale of Tender Document	From 05.02.2019 TO 26.02.2019
Last Date of Receipt of Tenders	Up to 3:00 PM ON 26.02.2019
Due Date of Opening	At 3:30 PM on 26.02.2019
Place of Opening	Office of SM (F&A), Marketing Department, Corporate Office, 4, Meera Marg, Udaipur- 313001
Cost of Non-Transferable Tender Documents	Rs. 590/- (Inclusive GST)



RAJASTHAN STATE MINES AND MINERALS LIMITED

(A Government of Rajasthan Enterprise)

Purchase Department, SBU & PC-Rock Phosphate

RSMML TENDER DOCUMENTS CONSIST OF FOLLOWING:

Section - I	Instruction for preparation & submission of tender
Section -II	Special Terms & Conditions
Annexure-I	Acceptance to the technical specification
Annexure – II	General profile of tenderer
Annexure – III	Registration details under Micro, Small & Medium Enterprises Development Act, 2006.
Annexure – IV	Exceptions & Deviation.
Annexure – V	Acceptance of all terms and conditions of the tender and no condition is mentioned in price bid.
Annexure – VI	Undertaking that tenderer has not been debarred/suspended by RSMML in past.
Annexure – VII	Declaration by the Tenderer.
Annexure – VIII	Details of commercial terms & conditions
Annexure-IX	Compliance with the code of Integrity and No conflict of interest.
Annexure-X	Declaration by the bidder regarding qualifications.
Annexure-XI	Grievance Redressal during Procurement Process.
Annexure-XII	Additional Conditions of Contract.
Annexure-XIII	Rate Schedule (Price-Bid)

SECTION – I: INSTRUCTION FOR PREPARATION & SUBMISSION OF TENDER

1. One copy of tender document should be sealed & signed as a token of acceptance of its terms and conditions and should be furnished along-with part -1 of tender (no page should be detached).
2. Tender must be submitted in two parts i.e. Techno - Commercial (Part – I) and Price Bid (Part –II). The tender should be packed in four sealed envelopes as elaborated below:
 - a. Sealed Envelop No. 1:- This envelop should contain DD/PO towards the tender document fee (incase the tender document has been downloaded from the website of RSMML or the copy of cash receipt (incase the tender document has been purchased from the office of SM-F&A) and DD/PO towards requisite BID SECURITY as per provisions mentioned in the tender document. This sealed envelope should be subscribed Tender Document Fee & Bid Security of Tender No (as mentioned above).
 - b. Sealed Envelop No. 2 : This envelop should contain Part –I: Techno-Commercial BID along-with all supporting documents (except the tender document fee, BID SECURITY & Price Bid) as asked in the tender document. This sealed envelope should be Super scribed Part – I of tender No (as mentioned above).

- c. Sealed Envelop No. 3 i.e. Part-II (PRICE BID): This envelop should contain only Price Part as per provisions mentioned in the tender. The sealed envelope should be super scribed PART – II (Price Part) of Tender No. (as mentioned above). No condition should be stipulated in this part, if mentioned any by tenderer, shall be ignored.
- d. Sealed Envelop No. 4: The above three sealed envelopes should be packed in another sufficiently large envelop to enable it to be opened without tearing the inner sealed envelopes. The outer cover should bear address of the authority who has invited tender and super-scribed there on Tender No (as mentioned above) and the details of above mentioned three envelops.
3. In compliance to the Rajasthan Transparency in Public Procurement Act, 2012 and Rajasthan Transparency in Public Procurement Rule, 2013, following Annexure are enclosed and tenderers are required to furnish duly filled, sealed and signed copies of these Annexure along-with Part-I of offer.
- Annexure-IX: Compliance with the Code of Integrity and No Conflict of Interest.
 - Annexure-X: Declaration by the Bidder regarding Qualifications.
 - Annexure-XI: Grievance Redressal during Procurement Process and Form No.1.
 - Annexure-XII: Additional Conditions of Contract.
4. The tenderer/bidder would give a declaration that they have not been banned/suspended or de-listed by RSMML. If this declaration is not given, the bid will be rejected as non responsive
5. **SALE OF TENDER:** The tender document (non-transferable) can be obtained from the office of SM (F&A), Marketing Department, Corporate Office, 4, Meera Marg, Udaipur-313001 on payment of applicable non-refundable tender fee of by Cash/Demand Draft/Pay-Order in favor of RSMML payable at Udaipur. Alternately interested tenderer(s) may directly download the tender document from website www.rsmm.com/ www.sppp.raj.nic.in and furnish their offer along with requisite tender document fee in a sealed envelope as prescribed at clause no. 2(a) of Section-I.
- 6. SUBMISSION & OPENING OF TENDER:**
- a. The submission and delivery of tenders within the specified date and time will be the sole responsibility of the Tenderer.
 - b. Tender should be submitted before due date & time at the **office of SM (F&A), Marketing Department, Corporate Office, 4, Meera Marg, Udaipur-313001.**
 - c. Place of opening of Tender: Part (I) of the tender would be opened on the due date & time at the **office of SM (F&A), Marketing Department, Corporate Office, 4, Meera Marg, Udaipur-313001** and Part (II) i.e. price bids of the qualified bidders would be opened later which would be informed to qualified bidders separately.
 - d. Tenders will be opened on the fixed date and time in the presence of Tenderer or their authorized representative who may wish to be present at the opening of the tender at the place, time and date as specified in the schedule. In case the date of opening of tenders happens to be a holiday, the tenders shall be opened on the next full working day at prescribed time.
7. **DELIVERY OF TENDER:** The submission and delivery of tenders within the specified date and time will be the sole responsibility of the Tenderer. In case the date of submission/opening of tender happens to be a holiday, than tenders shall be submitted/opened on the next full working day up to/at prescribed time.
- a. **Delayed Tender:** Tenders received after specified time & date of submission but before specified time & date of opening of part-I of the tender will be treated as delayed tender.
 - b. **Late Tender:** The tenders received after specified due date & time of opening of tender will be treated as late tender and will not be considered at all.
 - c. RSMML will not be responsible for delay in delivery of the tenders through post/speed post/courier/personal or any other means.

8. Tenderer should quote as far as possible in the form & pattern, as envisaged herein. It will help in making proper comparison & avoid any errors/emissions. Offers through Fax/e-mail/telegram will not be considered at all
9. Printed conditions on the back of letters originating from Tenderer will be ignored.
10. **EXCEPTIONS & DEVIATION:** Tenderer are advised to submit their offer based on terms, conditions and specifications contained in the tender document and not to stipulate any deviations. In case it is absolutely unavoidable to deviate from tender conditions & if a tenderer desires to propose any addition/deviation/alterations to any of the terms and conditions contained in the tender document, the same must be expressed clearly in Annexure-IV and should be furnished along with part-I of the offer, without making any corrections on the body of the tender document at their risk. In the absence of same it, it will be deemed as unqualified acceptance by the Tenderer to all the terms and conditions contained herein. Company may accept or not to accept the deviations put by the tenderer at its sole discretions. No claim on this will be entertained.
 - a. Tenderer should mention the deviations, if any, at their own risk of rejection of their offer
 - b. Deviations mentioned anywhere else in the offer shall be ignored without any consequences
11. Tenders containing corrections and alterations are liable to be rejected unless all such corrections and alterations are legible, clear signed & stamped by the tenderer.
12. Quotation qualified by such vague and indefinite expressions as "SUBJECT TO IMMEDIATE ACCEPTANCE" or "SUBJECT TO PRIOR SALE" is liable to be ignored
13. **TENDERER SHOULD FURNISH FOLLOWING AUTHENTICATED SUPPORTING DOCUMENTRY PROOF/DOCUMENTS ALONGWITH PART-I (TECHNO COMMERCIAL OFFER):**
 - a. One copy of complete tender document as issued duly filled and sealed & signed on each page by the tenderer as a token of acceptance of scope of work, terms & conditions of tender.
 - b. Demand Draft of Tender document fee, if the same is downloaded from the website as per clause no. 2(a) and Demand Draft/PO of Bid Security in the manner specified in tender as per clause no. 18.0 (Section-I).
 - c. Details in respect of satisfactorily supplying of similar nature of Stores in last two preceding years. Please enclose copies of Purchase Orders/performance certificate or repeat orders
 - d. In case of authorized dealers, furnish valid Authorization/Accreditation certificate from the manufacturer for participating in the tender
 - e. Detailed Technical leaflet of offered items, if required.
 - f. Confirmation to suitability and conformity of offered items, if required.
 - g. Copy of registration certificate under the Micro, Small & Medium Enterprises Development Act 2006, as per annexure-III.
 - h. Duly filled Annexure I to XII along with part-I of tender and Annexure-XIII (Price Bid) Part-II in separate sealed envelope (Envelope no. 3).
 - i. Any other relevant document, in support of eligibility criteria/terms & conditions of tender

Note: Each & every page of tender document, Annexure & documents furnished along with part I & Part II should be sealed & signed by the authorized person of the tenderer.
14. **BEFORE SUBMITTING TENDER:** Tenderer shall be deemed to have satisfied himself of all conditions liable to be encountered during the execution of the contract or rates quoted in the offer are adequate and all inclusive with respect to all factors

circumstances and conditions likely to be incidental/ encountered to the execution of the contract, as per the scope and conditions given herein.

15. **AUTHORITY TO SIGN TENDER:** The tender should be signed by the person who is legally authorized to enter into commitments on behalf of the Tenderer. The authorization letter should be enclosed.
16. **SCHEDULE OF RATES:** Rate should be quoted in the Schedule of Rates/Price Bid offer-Part II as per Annexure – XIII (appended hereto). The rate quoted should be both in figures and words. In case of any discrepancy between the figures and written words the lower of the two shall be taken as quoted rate. No conditions should be mentioned in the Price Bid Offer Part – II, in case, if any will be ignored.
17. **VALIDITY:** The tenderer shall keep the offer open for acceptance by RSMML for a minimum period of 120 Days from the date of opening of Part-I tender, within which period the tenderer shall have no right to withdraw, amend or modify his offer. In case of withdrawal/ amendment/modification the Bid security deposited by the Tenderer, as per clause No. 18 (Section-I) hereof, shall stand forfeited. The validity period may be extended further, if required, by mutual consent from time to time.
In case, tenderer, after issuance of communication of acceptance of offer by RSMML, fails to execute the contract as per the conditions of the contract, such an event will be considered as the tenderer calculated willful breach of the contract, the cost & consequence of which shall be on the sole account of the tenderer. Moreover, RSMML have full right to claim damages thereof in addition to the forfeiture of BID SECURITY
18. **BID SECURITY:**
 - a. The tenderer shall deposit (interest free) a sum of **Rs. 10040/-** (Rupees Ten Thousand Forty Only) as Bid Security along with the tender by Demand Draft/PO. It should be in favor of RSMML payable at Udaipur. Offers not accompanied with the requisite Bid Security will not be considered. Bid Security in any manner other than DD/PO will not be accepted.
 - b. The tenderer is to furnish the Bid Security as per provisions at clause 2.1 while opening of the tender, the envelope containing Bid Security will be opened first and in case the same is found as per tender requirement, then only the sealed envelope containing part-I & part- II of offer will be opened. The offer of the tenderer(s) who has not furnished Bid Security of requisite amount and in prescribed manner will not be considered
 - c. The EMD shall be forfeited in case of:
 - i. If tenderer unsolicited revises and/or modifies and/or withdraws and/or amends and/or cancels their tender at its own after submission of tender
 - ii. If it is established that tenderer have submitted any wrong information/forged document along-with the tender or thereafter/ found indulge in unfair trade practices
 - iii. If the tenderer declines to accept contract/order placed by the Company subsequent to acceptance of his offer
 - iv. If the tenderer does not submit the security deposit cum performance guarantee
 - v. If the tenderer breaches any promising provision of code of integrity Prescribed for bidder as detailed at Annexure-IX.
 - d. The Bid Security furnished by the unsuccessful tenderer will be refunded after finalization of tender / validity of the offer has expired. Bid Security of successful tenderer will be refunded after receipt of Security Deposit cum performance guarantee
 - e. The Bid Security of a tenderer lying with the company in respect of other tenders awaiting approval or rejected or on account of contract completed will not be adjusted towards Bid Security against this tender, however, the Bid Security originally deposited may be taken into consideration in case tender is re-invited
 - f. In case of participation by Undertakings, Corporations, Autonomous Bodies which are controlled and managed by Govt., Govt. Undertakings and Companies

of Union Govt. & Govt. of Rajasthan, they are exempted from deposition of Bid security

- g. Bid security will be taken @ 25% of the total value of Bid security of tender incase of participation by SSI unit of Rajasthan subject to that the tenderer has participated against the tender in a capacity of manufacturer of offered product
- h. Except above, no Bid security exemption will be given to any party on any grounds and their offer will liable for exemption

19.0 RELAXATION IN TENDER DOCUMENT FEES, BID SECURITY & SECURITY DEPOSIT

CUM PERFORMANCE GUARANTEE: Tenderers offering in capacity of micro, small and medium enterprises of the State of Rajasthan, having acknowledgement of Entrepreneurs Memorandum-II/Udyog Aadhaar Memorandum as mentioned in Micro, Small and Medium Enterprises Development Act, 2006, issued by the competent authority facilitated, on furnishing of a self-attested copy of acknowledgement of Entrepreneurs Memorandum-II/Udyog Aadhaar Memorandum, following relaxations will be provided-

- a. Tender document fees will be taken @50% of the prescribed total value of Tender document fees.
- b. Bid Security will be taken @25% of the total value of Bid Security. In case of offering the quantity lesser than the tendered quantity, then they can submit proportionate amount of bid security in proportion to the quantity being offered with respect to the bid security amount for tender quantity.
- c. Security Deposit will be taken @1% of the total value of order.
- d. Except above, no other exemption will be given to any party on any grounds and their offer will liable for rejection.

20.0 RSMML RIGHTS: The Company reserves to exercise the following rights at its sole discretion without assigning any reasons thereof. The decision of the Company in this regard shall be final and binding

- i. Not to accept any offer or reject any or all the offers.
- j. To reject any or all the tenders received or accept a tender either for the total Scope of Work or part thereof & not to accept the lowest tender without assigning any reason.
- k. To cancel the tender, postpone it for another date, change the venue of the receipt/opening of the tender.
- l. To increase/ decrease the tendered quantity.
- m. To split the tendered items into more than one tenderer.
- n. To accept/not to accept offered material, if not found technically suitable as per requirement of RSMML
- o. To reject the offer, if it is established that the tenderer has submitted any wrong & misleading information /forged document along with offer or thereafter.

For RAJASTHAN STATE MINES & MINERALS LIMITED,

DY. GENERAL MANAGER (MM)

I/ We have studied the above terms and conditions and having understood the same in true sense and spirit I/We shall abide by and adhere to the above terms and conditions fully.

Signature of Tenderer with official stamps

Date:

Place:

Section II: SPECIAL CONDITIONS OF CONTRACT (SCC)

1. SPECIFICATION, QUANTITY & SCOPE OF SUPPLY:

- a) Quantity & detail technical specification are as per annexure-I
- b) The scope of supply shall be the delivery of Stores by the supplier as per Annexure-I in accordance with the Terms and Conditions of the Tender.
- c) The supplier shall be deemed to have carefully examined and to have knowledge of the general and other conditions, schedules, and all other documents forming part of the contract, and also to have satisfied himself as to the nature and character of the Stores to be delivered under the contract.
- d) The supplier shall be entirely responsible for the performance of the contract in all respects according to the intent and meaning of the specification data.

2. EVALUATION OF TENDER:

- a. Pre-qualifying criteria:
 - i. The tenderer should be manufacturer/distributors/bonafide dealers for which valid proof should be furnished along with tender document.
 - ii. Clientele served of similar nature of stores during last two years along with photocopies of orders/repeat orders/performance certificates, if any;
 - iii. The tenderer who fails to furnish the prescribed EMD shall not be eligible for price bid opening;
- b. The techno-commercial suitability of the offers will be ascertained on the basis of pre-qualifying criteria, past track record of the suppliers to supply of similar technical specifications, the quantum and performance of such supplies on the basis of documents submitted along with the Tender (Part-I of the offer). The decision of the Company with regard to short-listed bidders shall be final and binding to tenderers.
- c. Price Part (Part-II) of the offer of only short-listed tenderers will be opened and only such short-listed tenderers will be informed about the date and time of opening of the price bid. The company will generally not entertain any correspondence on this subject.

3. DETERMINATION OF LOWEST BIDDER:

- a. For evaluation purpose lowest tenderer shall be determined separately for each item on the basis of total landed cost of material at destination inclusive of all duties, taxes, transportation charges, Freight, Insurance, P & F, any other delivery charges up to destination (Excluding GST and giving effect of any other duties/taxes/levies /exemption/by the State/ Central Govt. which are applicable directly / indirectly on the supply/use of Conveyor Material. On similar basis L2, L3, L4..... Tenderers will be determined.
- b. In case RSMML opt for placing the purchase order to more than one tenderer, then initially L2 tenderer will be extended opportunity to match L1 rate after giving effect, as above, on refusal by L2 tenderer, then to L3 tenderer & so on.
- c. In the event the company does not find the lowest quoted rate, acceptable to it, then the tender will be scrapped and may be re-invited, or company may take any other suitable action as deemed fit looking to the exigency of the work.

4. NEGOTIATIONS:

- a. Negotiations will be conducted with the lowest tenderer only. In case of non-satisfactory achievement of rates from lowest tenderer, RSMML may choose to make a written counter offer to the lowest tenderer and if this is not accepted, RSMML may decide to reject and re-invite fresh tenders or to make the same counter-offer first to the second lowest tenderer, then to the third lowest tenderer and so on in the order of initial bidding, and work order be awarded to the tenderer who accepts the counter offer.
- b. In the case, when the quotations given by the tenderer during negotiations is higher than the original quotation of the tenderer then the tenderer will be bound by the lower rate originally quoted by the tenderer.
- c. In case of negotiations, representative of the tenderer attending negotiations must possess written authority from the tenderer to the effect that he is competent to modify/amend the submitted tender deviations and rates offered by them.

- d. In the event the company does not find the lowest quoted rate, acceptable to it, then the tender will be scrapped and may be re-invited, or company may take any other suitable action as deemed fit looking to the exigency of the work.
5. **NO COMPENSATION FOR ALTERATION OF DELIVERY SCHEDULE OR SUSPENSION OF SUPPLIES:** If at any time after commencement of the supply, if the Company, for any reason, whatsoever do not require the whole supply or part thereof as specified in the AT, shall give notice in writing of the same to the supplier and the supplier shall not be entitled for any compensation and/or damage of any kind whatsoever on account for loss or profit etc. nor the contractor be entitled to any claim for compensation for re-scheduling of delivery period.
6. **SECURITY DEPOSIT-CUM-PERFORMANCE GUARANTEE:**
- a. As security for due, proper and faithful fulfillment of the obligations under the contract, the tenderer will furnish to RSMML, Security Deposit-cum-Performance Guarantee of **5% of total value of order** by way of Demand Draft/Pay Order or in the form of Bank Guarantee in RSMML proforma from any Public Sector/ICICI/HDFC/AXIS Bank (except SBI) having its branch at Udaipur, within 21 days from the date of receipt of intimation of RSMML's acceptance of the tender. The Bank Guarantee should be valid for a period of 3/6 month in excess of the warrantee period/work completion period.
 - b. In case SD is being furnished in the form of Bank Guarantee, the BG should be furnished on the non-judicial stamp paper of the value equal to 0.1% (Zero Point One Percent) of security deposit or of Rs. 200/- whichever is higher.
 - c. The SD shall be liable to be invoked/amount of SD is liable to be forfeited wholly or partly at the sole discretion of the Company, should the supplier either fails to execute the work within the stipulated period or fails to fulfill the agreed obligations or fails to settle in full, it's dues to the Company.
 - d. The Company is empowered to recover from the SD any sum due and/or any other sum that may be fixed by the Company as being the amount or loss or losses or damages suffered by it due to unsatisfactory performance or non-fulfillment of any of the conditions of the tender/contract.
 - e. The Bank Guarantee/SD shall remain in force and binding, notwithstanding, if any variation, alteration, modification etc. are made to the contract or any extension of the contract period are granted by RSMML.
 - f. RSMML shall not pay any interest on the Security Deposit. The Security Deposit shall be released on application by the contractor after expiry of guarantees and after discharge of all the supplier's obligations under the contract.
 - g. The said Security Deposit shall not in any way be construed as a limitation of the supplier's responsibility or liability pertaining to its obligations and guarantees under the contract and shall be without prejudice to any remedies available to RSMML in terms of the contract and or as per the laws of the land.
 - h. Bank Guarantee/SD should be sent to the office of Dy. General Manager (MM), RSMML Ltd., Jhamarkotra Mines
8. **INSPECTION:**
- a. RSMML shall have the right to inspect and/or to test the goods to confirm their conformity to the order. Inspection may be carried out at Supplier's end &/or consignee's end.
 - b. However, final inspection shall be carried out at consignee's end which will be final and binding to both the parties. All reasonable facilities and assistance including access to technical data, drawings etc. shall be furnished by the tenderer to the inspector at no charge to facilitate inspection.
 - c. In case of rejection of any item, the same should be replaced, to meet specification requirements, by the tenderer at their own risk & cost.
 - d. The inspection/test reports shall in no way release the tenderer from any warrantee or other obligation under this contract
9. **PRICES:**

- a. Price should be quoted as per Annexure –XIII (Price Bid) for supply of tendered items, annexed hereto. Prices should be quoted in Indian Rupees only.
- b. Price quoted must be net per unit, and should be offered on FOR destination basis at Jhamarkotra Mines, including transportation, insurance & other delivery charges up to destination.
- b. Price will remain firm and fixed till the complete execution of the contract.
- c. Please quote the duties and taxes as applicable on the date of submission of offer clearly and separately against each item. In the event of any increase/decrease in the Taxes & duties by the Government, the difference of the same shall be passed on to the tenderer/RSMML as the case may be. The increase shall be payable only on the production of authentic documentary proof by the tenderer.
- d. Save and except as aforesaid, the tenderer shall not be entitled to raise any claim and/or demand and/or any dispute on account of escalation or raise or increase in the prices of any other item or element.
- e. Timely deposition of GST and filing of requisite tax returns of relevant tax period would be the sole responsibility of the contractor. The contractor will also ensure that necessary credit on this account is available to RSMML in the next month. In case of any discrepancy, where credit is not available to RSMML, then company is free to deduct/recover/retain such amount from the bills of contractor or any other amount due to him/or from security deposit, as the case may be.
- f. In case of reversal of Input tax credit (ITC), imposition of penalty on account of payment of GST and default in filing of returns towards the payment for the work, contractor is liable to pay all such dues to the company, failing which RSMM is free to deduct/recover/retain such amount from the bills of contractor or any other amount due to him/or from security deposit, as the case may be.

10. **DELIVERY TERMS:**

- a. The delivery of the stores is required Ex. stock and should be dispatched as soon as the orders are placed. The tenderer should state the earliest delivery period they can offer for full or part quantity.
- b. Should the supplier fail to deliver the stores in full or part within the delivery period of the contract, Company will be entitled to cancel the contract in full or for undelivered portion and to purchase at the risk and cost of the tenderer

11. **CONSIGNEE:** The Consignee is Dy. General Manager (MM), RSMM Ltd., P.O. Jhamarkotra Mines, Dist. Udaipur or his authorized representative

12. **INSURANCE:** In case the materials are ordered on F.O.R Destination basis, the supplier shall insure the Stores against all transit risk from warehouse to warehouse basis at his own cost.

13. **TERMS OF PAYMENT & PAYING AUTHORITY:**

- a. Payment terms are 100% within 30 days on receipt and acceptance of goods at Jhamarkotra Mines stores.
- b. Billing & Paying Authority: The bill in triplicate along-with the supporting documents duly verified by the consignee will be released by Payment disbursing authority – The Payment disbursing authority is HOD (F&A), Jhamarkotra Mines.
- c. Payment will be made through RTGS/NEFT. All bank charges/ commission, if any, shall be borne by the supplier

14. **MANUFACTURER:** In case the tenderer is Dealers/Distributors/Sole Agents, the name of the manufacturers for the Stores will be indicated. The manufacturer's valid Authorization Certificate to participate in the tender should be enclosed.

15. **TECHNICAL DATA:** Stores shall confirm the technical specifications as per **Annexure-I**. In case tenderers are on the Rate/Running contract with the DGS&D, a copy of Rate/Running Contract price of DGS&D will also be produced by the tenderer.

16. **PRICE VARIATION:** The quoted price should remain firm and fixed till the completion of supplies. Only variation on account of changes in Taxes & Duties by the Government will be considered. No escalation/ variation on any other grounds whatsoever shall be considered or be admissible:
- Escalation on Government Taxes & Duties: The tenderer will indicate in his offer the applicable Taxes & Royalty at the time of opening of Part-I offer. In the event of any increase/decrease in the Taxes & royalty by the Government, the difference of the same shall be passed on to the Contractor/RSMML as the case may be. The subsequent increase/decrease shall be payable only on the production of authentic documentary proof by the Contractor.
 - Save and except as aforesaid, the contractor shall not be entitled to raise any claim and/or demand and/or any dispute on account of escalation or raise or increase in the prices of any other item or element whether in respect of electrical charges, high speed diesel, oil, lubricants, tyres, tubes, spares, wages or minimum wages of workmen either statutory or contractual under any settlement or award or otherwise or on any other ground/or reason whatsoever.
 - Suitable price variation clause may be added on case to case basis where price escalation/de-escalation is to be passed on depending upon price variation of any input material
17. **COMPENSATION FOR DELAYED DELIVERY:** Should the contractor fail to deliver the stores in full/part within the delivery date the Company shall be entitled at its option either:
- To recover from the contractor as agreed compensation @ 0.5% of the value of the undelivered stores, for each week or part thereof subject to a maximum of 5% of value of undelivered store.
- OR**
- To purchase from elsewhere, without notice to supplier at his risk and cost of full undelivered part, as the case may be.
- OR**
- To cancel the contract in full or for the undelivered portion and to purchase or authorize purchase at the risk and cost of the supplier.
- OR**
- Company will be empowered to repurchase in such case (b&c) above, stores which are readily available to meet his requirements, irrespective of the fact whether these are similar or not
18. **ASSIGNMENT:** The contractor shall not sublet, transfer or assign this contract or any part thereof (or any benefit or interest therein and there under) without written consent of the company. But such consent of the company, if given shall not relieve the contractor from any liability or obligation under this contract and the contractor shall be responsible for all acts, defaults and neglects of the sub-contractor, his agents and employees fully as if those are the Contractor 's own acts.
19. **INDEMNIFICATION:** Except where arising from the negligence of RSMML or RSMML's employees, the supplier shall indemnify RSMML in respect of any costs or damages, whatsoever arising out of or related to breach of statutes, laws, acts, rules and regulations, damage, accident or loss etc. by the supplier or suppliers personnel or by claims made against RSMML by third parties in respect thereof.
20. **PERFORMANCE GUARANTEE:** The tenderer shall guarantee that the stores under the contract shall be free from all defects for a minimum period of Twelve months from the date of fitment of stores or Eighteen months from date of invoice, whichever is earlier. If at any time during the guarantee period, the stores do not confirm the Company's requirements/specifications and/or do not meet the desired performance/specifications the supplier will lift the material at its own expenses within a time to be specified by the Consignee. In the event the tenderer failing to do so, the Company shall take appropriate action and the expenses on this account forthwith be reimbursed by the tenderer/adjusted from any due payment without prejudice to the Company's any other rights and/or remedies provided in the contract or by the relevant provision of Law.

21. **PRICE FALL CLAUSE:** In the event of supplier accepting lower prices for supplies covered under the contract to any other companies during the pendency of the contract, the lower price and charges will also be applicable to this contract. The supplier must intimate RSMML as soon as they accept lower prices from any other company including PSU and Government Organization.

22. **TERMINATION:**

a. In case of failure to perform the job as required under this tender or observe breach of any of the terms and conditions by the tenderer, the company shall give a notice to rectify such default/breach may result in termination of the Purchase Order and forfeiture of Security Deposit without any prejudice to the Company's rights to claim damages/cost/ loss etc. caused by such default/breach. Such termination shall not absolve the supplier of the liabilities accruing till the date of such termination.

b. b) The contract may also be terminated in the event the supplier is being adjudged insolvent or going into Liquidation or Winding up of their business, or making arrangement with their creditors.

Notwithstanding anything contained herein above, the Company in its absolute discretion may at any time terminate the order without assigning any reason thereof by giving fifteen day's notice to the supplier at their last notified address. In such an event the supplier shall not be entitled to raise any claim or demand for compensation, loss of profit and/or damages and/or losses or costs by reason of such earlier termination on any ground whatsoever

23. **INDIAN/BSS STANDARD:** All specification mentioned in the tender documents are based on Indian Standards or equivalent and where no Indian standards exists the supplies conform to B.S.S. All electric installations, equipments etc shall have to conform to Indian Electricity Rules 1967 and as amended from time to time.

24. **FORCE MAJEURE:** At any time, during the continuance of the contract, the performance in whole or in part by either party (sub-vendors excluded) and/or obligations under this contract shall be prevented or delayed by reason of any war, hostility acts of public enemy, civil commotion, sabotage, fires, floods, explosion, epidemics, quarantine restrictions, non-performance due to labour strikes, lock-outs and Acts of God or Acts of Government/statutory bodies (hereinafter referred as "Event") then provided a notice of the happening of any such event is given within **seven days** from the date of occurrence thereof neither party shall by reason of such event be entitled to terminate this contract nor shall either party have any claim for damage against the other in respect of such non-performance or delay in performance and the deliveries and/or performance of the work under the contract shall be resumed as soon as practicable after such event has come to an end or ceased to exist and decision of Company as to whether the deliveries and/or performance of the work have been so resumed or not shall be final and conclusive. Provided further that if the performance in whole or in part is delayed by reasons of any such events for a period exceeding **thirty days** either party may at its option terminate the contract.

25. **JURISDICTION:** The contract is subject to the jurisdiction of courts of Udaipur in the state of Rajasthan

For RAJASTHAN STATE MINES & MINERALS LIMITED,

DY. GENERAL MANAGER (MM)

I/ We have studied the above terms and conditions and having understood the same in true sense and spirit I/We shall abide by and adhere to the above terms and conditions fully.

Signature of Tenderer with official stamps

Date & Place:

ACCEPTANCE TO THE TECHNICAL SPECIFICATION

(To be enclosed with part-I of offer)

S. No	Description/ Specification of Material	Unit	Qty	Deviation, if any
1	Head Well with Lateral Wall Tip R .H. (Part No. 001.475.38.298 00M)	Nos.	2	
2	Head Well with Lateral Wall Tip L.H. (Part No. 002.475.38.297 00M)	Nos.	2	
3	Plate Sail Hard / Tiscral, 25 MM X 1250MM X 3000 MM, 25MM Thick	MT	2	
4	“U” Clamp with 2 Nut & M.S. Plate L-125MM, Ø12M Part No. L-125, Ø12MM (as per enclosed drawing RSMM/JKT/IBP-LGO/2014/U1001	Nos.	500	
5	Head Valve Set (Left and Right) Complete assembly consist of two head valve Left right with all SS 316 hardwares (MOC-Hardox-450)	Set	2	

Note: -

1. Item Sr. no. 01 & 02 below Points (A, B, C & D) to be noted and fulfilled at the time of Supply.
 - a. Base Plate Material should be Sail Hard Steel of High Grade.
 - b. Wear Resistance Plate above base plate Hardness as per Hardox 400®
 - c. Bend in head valve plate will not acceptable.
 - d. Material Test certificate must be include.
2. Item Sr. no. 03 "Any other suitable size i. e Length or width may be acceptable".
3. Item Sr. no. 05 below Points (A & B) to be noted.
 - a. Base Material should be of Hardox ® - 450 Plate make - SSAB SWEEDEN. Import and purchase certificate should be furnished during supply.
 - b. Base material should be at Zero degree, deformation or bending due to welding is not acceptable.

Special Notes:

1. The given drawings are tentative only, interested bidder may visit our site if they desire to ensure actual dimensions. Supplier should also confirm fitment guarantee i.e. proper fitment of items in our assembly.
2. If, there is any deviation it should be specifically mentioned for proper evaluation of offer.

We hereby confirm and accept to supply of material as per above specifications.

Signature of Tenderer with official stamps

Date & Place

Note: - Supplier should get the drawing approved by us before manufacturing of the items.

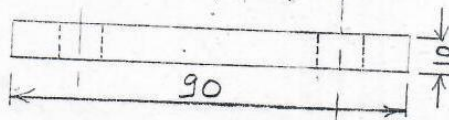
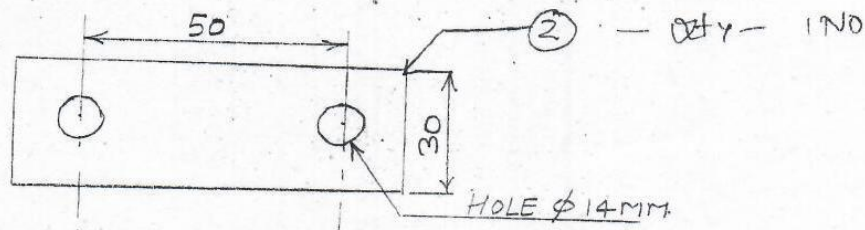
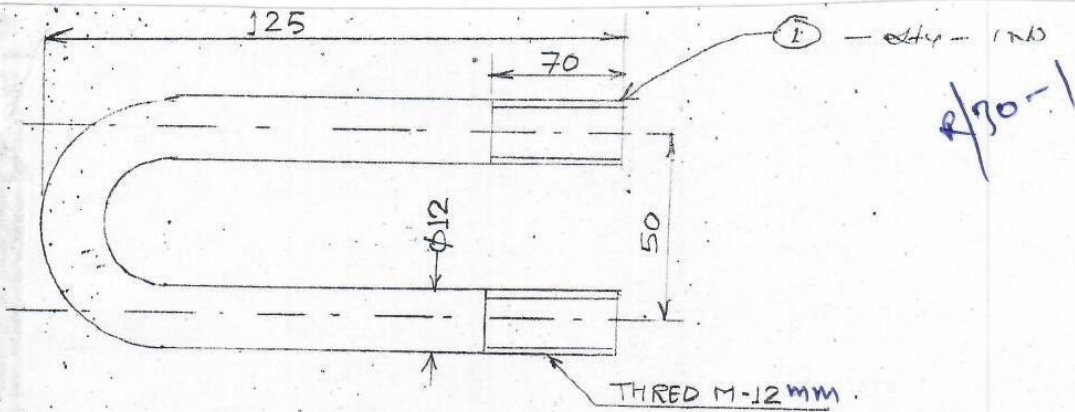

③ - Nut M-12-2NDI

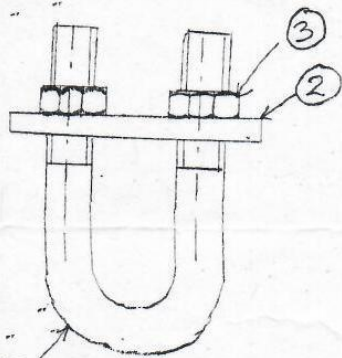

ASSY OF U-clamp.

ALL DIMENSION ARE IN MM

MATERIAL :- M.S. (high tensile)

SCALE :- N.T.S.

R'SMM LTD JHAMER KOTRA
UDAIPIUR

DRG NO. R'SMM/JKT/IBP-L60/2014/VI001

PREPARED BY

Naw
28/02/2014

CHECKED BY

Isakant
19/02/14

APPROVED BY

Lawat
20.2.14

U-CLAMP FOR
SCREEN. I & II
AT
LGO(CSR)

Prakesh
28/11/2018

Roller Press Head Valves Right and Left

Front View of Left and right
View of Left and right

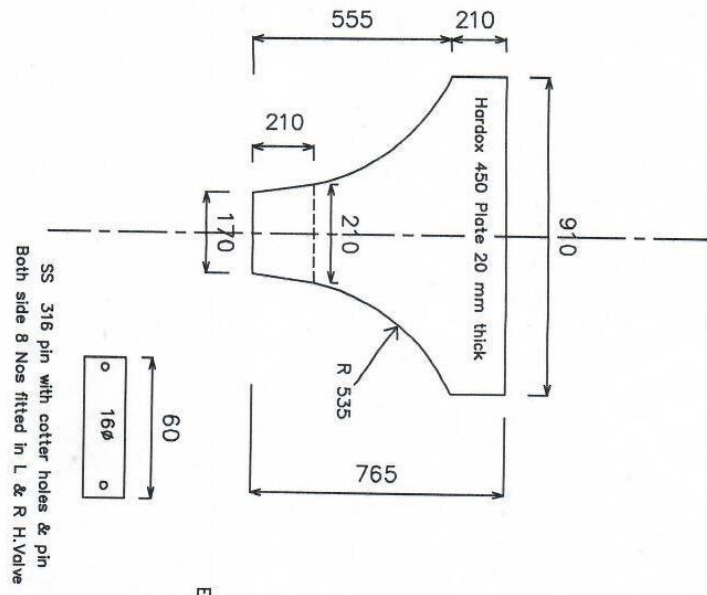

Back View
Left Head Valve

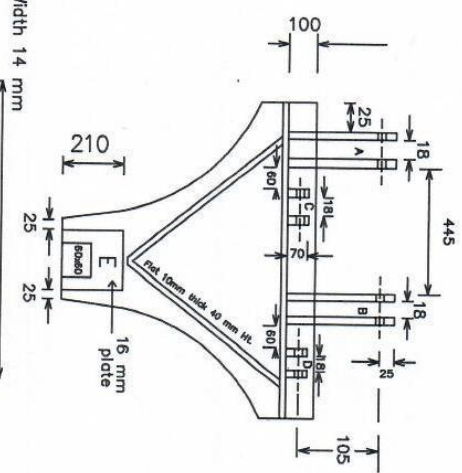

Back View
Right Head Valve

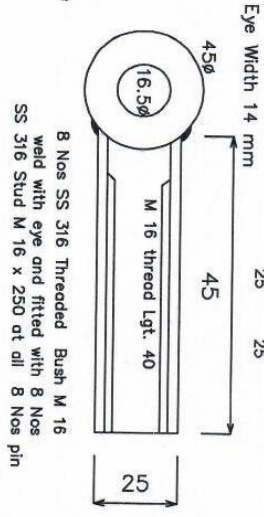
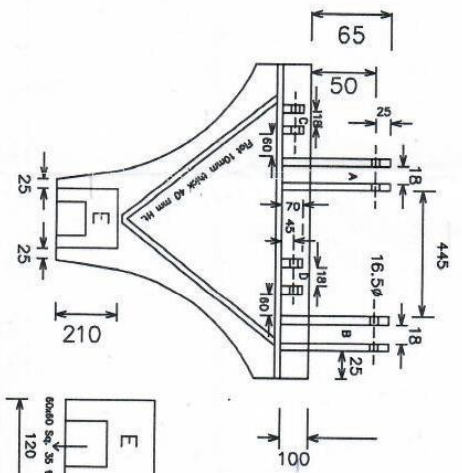

8 Nos SS 316 Threaded Bush M 16
weld with eye and fitted with 8 Nos
SS 316 Stud M 16 x 250 at all 8 Nos pin

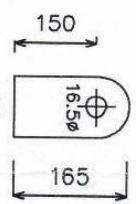

Small Big bracket 40 wide 10 mm thick
welded with base plate and Flat

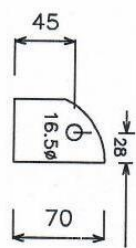

Single Machined Sail hard plate of 35 mm
welded on H. Valve plate at back side

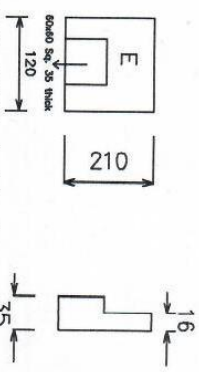

Note - 1. Base Material should be of Hardox*-450 plate SSAB
Sweden. Make and Purchase certificate should be
furnish during Supply
2. Base Plate should be at zero degree, bend deformation
/ bending due to welding is not acceptable

IBP / MPP / Mech / RP / Head valve / VD / 216 / 2018

Handwritten signature and date: 12.11.18

Handwritten number: 218-1

GENERAL PROFILE OF TENDERER

(To be submitted - part – I of the offer)

1	Name & address of the tenderer with contact details.			
2	Name, email id & contact Nos. of Authorized Person dealing with tender			
3	Status of Tenderer i.e. Manufacture/ Authorized Dealer/Bonafide Dealer/any other.			
4	Whether Proprietor/Partnership/Company.			
5	Name of owner/partners Directors with full address.			
6	Annual turnovers in rupees for last three years (in lacs)	2017-18	2016-17	2015-16
7	PAN /GST No.			
8	TIN No.			
9	Service Tax Registration no.			
10	Entrepreneurs Memorandum no. as per MSMED Act 2006			
11	Banker details:			
	a) Name			
	b) Branch No.			
	c) Address			
12	Bank Account No.			
13	Type of A/c:Saving/Current/CC/other			
14	IFSC code			
15	Are you exempted from paying; custom Duty/Excise Duty/Sales Tax, if yes give details.			
16	Any other important information			

Signature of tenderer with official stamp

Date & Place:

**DECLARATION FOR REGISTRATION UNDER MICRO, SMALL & MEDIUM
ENTERPRISES DEVELOPMENT ACT, 2006**

(To be submitted along with part – I of the offer)

1. Whether the tenderer is registered under Micro, Small & Medium Enterprises Development Act, 2006. _____(Yes/NO)

2. If yes, please furnish the declaration given below.

We (Name of Tenderer _____), hereby declare that, our organization is registered under Micro, Small & Medium Enterprises Development Act, 2006 as _____(Micro, Small & Medium) Enterprises, having entrepreneurs Memorandum no. _____ and under category of _____ (Manufacturer/service)

3. Enclose attested copy of registration certificate.

Signature of tenderer with official stamp

Date:

Place:

EXCEPTION & DEVIATIONS

(To be submitted along-with part – I of the offer)

Name of Tenderer _____

Tenderer may stipulate here exceptions and deviations to the tender conditions, if considered unavoidable.

S. No.	Tender Clause no.	Requirement as per tender clause	Offered condition/ Deviation

Note: In case the tenderer does not mention any information to the deviations in the above format & furnish it blank then it will be presumed that the tenderer is not offering/ putting any deviations to the tender terms & condition.

We confirm that we have not put any other deviations to the tender terms & conditions except to the above.

Signature of tenderer with official stamp

Date:
Place

**UNDERTAKING TOWARDS ACCEPTANCE OF ALL TERMS & CONDITIONS
OF TENDER AND NO CONDITION MENTIONED IN PRICE BID**

(To be submitted - part - I of the offer)

Name of Tenderer _____

- I) We confirm that all the terms & conditions of tender are accepted to us and we will supply the material as per technical specifications of tender.
- II) We hereby undertake that we have not mentioned any condition in the price bid.

Signature of tenderer with official stamp

Date:

Place:

ANNEXURE-VI

DECLARATION OF NON SUSPENSION/NON BANNING

(To be submitted - part - I of the offer)

Name of the Tenderer: _____

We hereby declare that we have not been banned/suspended or de-listed by RSMML in past.

Signature of Tenderer with official stamp

Date:

Place:

ANNEXURE - VII

DECLARATION BY TENDERER

I/We declare that I am/we are manufacturer/authorised dealer/ Importers/ Bonafide dealers in the goods/stores/equipments for which I/We have tendered.

If this declaration is found to be incorrect then without prejudice to any other action that may be taken, my/our bid security/security deposit may be forfeited in full and the tender if any to the extent accepted may be cancelled.

Signature of tenderer with official stamp

Date:

Place:

DETAILS OF OFFERED COMMERCIAL TERMS

(To be submitted - part – I of the offer)

Particulars	Offered Terms
Price Basis	For Destination
CGST	@.....%
SGST	@.....%
IGST	@.....%
GST on Transportation and other charges	@.....%
Offered Delivery PeriodDays

Signature of tenderer with official stamp

Date:

Place:

Compliance with the Code of Integrity and No Conflict of Interest

(To be submitted - part – I of the offer)

Any person participating in a procurement process shall –

- a) Not offer any bribe, reward or gift or any material benefit either directly or indirectly in exchange for an unfair advantage in procurement process or to otherwise influence the procurement process;
- b) Not misrepresent or omit that misleads or attempts to mislead so as to obtain a financial or other benefit or avoid an obligation;
- c) Not indulge in any collusion, Bid rigging or anti-competitive behaviour to impair the transparency, fairness and progress of the procurement process;
- d) Not misuse any information shared between the procuring Entity and the Bidders with an intent to gain unfair advantage in the procurement process;
- e) Not indulge in any coercion including impairing or harming or threatening to do the same, directly or indirectly, to any party or to its property to influence the procurement process;
- f) Not obstruct any investigation or audit of a procurement process;
- g) Disclose conflict of interest, if any, and
- h) Disclose any previous transgressions with any Entity in India or any other country during the last three years or any debarment by any other procuring entity.

Conflict of Interest:-

The Bidder participating in a bidding process must not have a Conflict of Interest.

A Conflict of Interest is considered to be a situation in which a party has interests that could improperly influence that party's performance of official duties or responsibilities, contractual obligations, or compliance with applicable laws and regulations.

- i) A Bidder may be considered to be in Conflict of Interest with one or more parties in a bidding process if, including but not limited to:
 - a) Have controlling partners/shareholders in common; or
 - b) Receive or have received any direct or indirect subsidy from any of them; or
 - c) Have the same legal representative for purposes of the bid; or
 - d) Have a relationship with each other, directly or through common third parties, that puts them in a position to have access to information about or influence on the bid of another Bidder, or influence the decisions of the Procuring Entity regarding the bidding process; or
 - e) The Bidder participates in more than one bid in a bidding process. Participation by a Bidder in more than one bid will result in the disqualification of all bids in which the Bidder is involved. However, this does not limit the inclusion of the same subcontractor, not otherwise participating as a Bidder, in more than one bid; or
 - f) The Bidder or any of its affiliates participated as a consultant in the preparation of the design or technical specifications of the Goods, Works or Services that are the subject of the bid; or
 - g) Bidder or any of its affiliates has been hired (or is proposed to be hired) by the Procuring Entity as engineer-in-charge/consultant for the contract.

Declaration by the Bidder regarding qualifications Declaration by the Bidder

(To be submitted - part – I of the offer)

In relation to my/our Bid submitted tofor procurement ofin response to their Notice Inviting Bids No..... datedI/we hereby declare under Section 7 of Rajasthan Transparency in Public Procurement Act 2012, that :

1. I/we possess the necessary professional, technical, financial and managerial resources and competence required by the Bidding Document issued by the Procuring Entity;
2. I/we have fulfilled my/our obligation to pay such of the taxes payable to the Union and the State Government or any local authority as specified in the Bidding Document;
3. I/we are not insolvent, in receivership, bankrupt or being wound up, not have my/our affairs administered by a court or a judicial officer, not have my/our business activities suspended and not the subject of legal proceedings for any of the foregoing reasons;
4. I/we do not have, and our directors and officers not have been convicted of any criminal offence related to my/our professional conduct or the making of false statements or misrepresentations as to my/our qualifications to enter into a procurement contract within a period of three years preceding the commencement of this procurement process, or not have been otherwise disqualified pursuant to debarment proceedings;
5. I/we do not have a conflict of interest as specified in the Act, Rules and the Bidding Document, which materially affects fair competition;

Date:	Signature of bidder
Place:	Name:
	Designation:
	Address:

Grievance Redress during Procurement Process

(To be submitted - part – I of the offer)

The designation and address of the First Appellate Authority is: Mines Dept, GOR

The designation and address of the Second Appellate Authority is: Finance Dept., GOR

- 1) **Filing an appeal** : If any Bidder or prospective bidder is aggrieved that any decision, action or omission of the Procuring Entity is in contravention to the provisions of the Act or the Rules or the Guidelines issued there under, he may file an appeal to First Appellate Authority, as specified in the Bidding Document within a period of ten days from the date of such decision or action, omission, as the case may be clearly giving the specific ground or grounds on which he feels aggrieved: Provided that after the declaration of a Bidder as successful the appeal may be filed only by a Bidder who has participated in the procurement proceedings: Provided further that in case a Procuring Entity evaluates the technical bids before the opening of the financial Bids, an appeal related to the matter of Financial Bids may be filed only by a Bidder whose Technical Bid is found to be acceptable.
- 2) The officer to whom an appeal is filed under para (1) shall deal with the appeal as expeditiously as possible and shall endeavor to dispose it of within thirty days from the date of the appeal.
- 3) If the officer designated under para (1) fails to dispose of the appeal filed within the period specified in para (2) or if the Bidder or prospective bidder or the Procuring Entity is aggrieved by the order passed by the First Appellate Authority, the bidder or prospective bidder or the Procuring Entity, as the case may be, may file a second appeal to Second Appellate Authority specified in the Bidding Document in this behalf within fifteen days from the expiry of the period specified in para (2) or of the date of receipt of the order passed by the First Appellate Authority, as the case may be .
- 4) **Appeal not to lie in certain cases** : No appeal shall lie against any decision of the Procuring Entity relating to the following matters, namely:-
 - a) Determination of need of procurement;
 - b) Provisions limiting participation of Bidders in the Bid process;
 - c) The decision of whether or not to enter into negotiations ;
 - d) Cancellation of a procurement process;
 - e) Applicability of the provisions of confidentiality.
- 5) **Form of Appeal**
 - a) An appeal under para (1) or (3) above shall be in the annexed form along-with as many copies as there are respondents in the appeal;
 - b) Every appeal shall be accompanied by an order appealed against, if any, affidavit verifying the facts stated in the appeal and proof of payment of fee.
 - c) Every appeal may be presented to First Appellate Authority or Second Appellate Authority, as the case may be, in person or through registered post or authorized representative.
- 6) **Fee for filing appeal**
 - a) Fee for the first appeal shall be rupees two thousand five hundred and for second appeal shall be rupees ten thousand, which shall be non-refundable.
 - b) The fee shall be paid in the form of bank demand draft or bankers' cheque of a Scheduled Bank in India payable in the name of Appellate Authority concerned.
- 7) **Procedure for disposal of appeal**
 - a) The First Appellate Authority or Second Appellate Authority, as the case may be, upon filing of appeal, shall issue notice accompanied by copy of appeal, affidavit and documents, if any, to the respondents and fix date of hearing.
 - b) On the date fixed for hearing, the First Appellate Authority or Second Appellate Authority , as the case may be, shall –
 - (i) Hear all the parties to appeal present before him; and
 - (ii) Peruse or inspect documents, relevant records or copies thereof relating to the matter.
 - c) After hearing the parties, perusal or inspection of documents and relevant records or copies thereof relating to the matter, the Appellate Authority concerned shall pass an order in writing and provide the copy of order to the parties to appeal free of cost.
 - d) The order passed under sub-clause (c) above shall also be placed on the State Public Procurement Portal.

**Memorandum of Appeal under the Rajasthan Transparency in Public
Procurement, Act 2012**

(To be submitted - part – I of the offer)

Appeal No..... of

Before the(First /Second Appellate Authority)

1. Particulars of appellant :

(i) Name of the appellant :

(ii) Official address, if any:

(iii) Residential address:

2. Name and address of the respondent(s) :

(i)

(ii)

(iii)

3. Number and date of the order appealed against and name and designation of the officer/authority who passed the order (enclose copy), or a statement of a decision, action or omission of the Procuring Entity in contravention to the provisions of the Act by which the appellant is aggrieved:

4. If the Appellant proposes to be represented by a representative, the name and postal address of the representative :

5. Number of affidavits and documents enclosed with the appeal :

6. Ground of appeal:.....

.....

.....

.....(Supported by an affidavit)

7. Prayer:.....

.....

Appellant's signature :

Place:

Date:

Additional Conditions of Contract

(To be submitted - part – I of the offer)

- 1. Correction of arithmetical errors :** Provided that a Financial Bid is substantially responsive, the Procuring Entity will correct arithmetical errors during evaluation of Financial Bids on the following basis:
 - i) if there is a discrepancy between the unit price and the total price that is obtained by multiplying the unit price and quantity, the unit price shall prevail and the total price shall be corrected, unless in the opinion of the Procuring Entity there is an obvious misplacement of the decimal point in the unit price, in which case the total price as quoted shall govern and the unit price shall be corrected;
 - ii) If there is an error in a total corresponding to the addition or subtraction of sub totals, the subtotals shall prevail and the total shall be corrected; and
 - iii) If there is a discrepancy between words and figures, the amount in words shall prevail, unless the amount expressed in words is related to an arithmetic error, in which case the amount in figures shall prevail subject to (i) and (ii) above.

If the Bidder that submitted the lowest evaluated bid does not accept the correction of errors, its bid shall be disqualified and its Bid Security shall be forfeited or its Bid Securing Declaration shall be executed.

- 2. Procuring Entity's Right to Vary Quantities**
 - (i) At the time of award of contract, the quantity of Goods, works or services originally specified in the Bidding Document may be increased or decreased by a specified percentage, but such increase or decrease shall not exceed twenty percent, of the quantity specified in the Bidding Document. It shall be without any change in the unit price or other terms and conditions of the bid and the conditions of contract.
 - (ii) If the Procuring Entity does not procure any subject matter of procurement or procures less than the quantity in the Bidding Document due to change in circumstances, the bidder shall not be entitled for any claim or compensation except otherwise provided in the conditions of contract.
 - (iii) In case of procurement of goods or services, additional quantity may be procured by placing a repeat order on the rates and conditions of the original order. However, the additional quantity shall not be more than 50% of the value of goods of the original contract and shall be within one month from the date of expiry of last supply. If the supplier fails to do so, Procuring Entity shall be free to arrange for the balance supply by limited bidding or otherwise and the extra cost incurred shall be recovered from the supplier.

- 3. Dividing quantities among more than one bidder at the time of award (In case of procurement of goods):** As a general rule all the quantities of the subject matter of procurement shall be procured from the bidder, whose bid is accepted. However, when it is considered that the quantity of the subject matter of procurement to be procured is very large and it may not be in the capacity of the bidder, whose bid is accepted, to deliver the entire quantity or when it is considered that the subject matter of procurement to be procured is of critical and vital nature, in such cases, the quantity may be divided between the bidder, whose bid is accepted and the second lowest bidder or even more bidders in that order, in a fair, transparent and equitable manner at the rates of the bidder, whose bid is accepted.

PART-II (PRICE BID) for NIT-44/18-19 dated: 05.02.2019

SUPPLY OF FABRICATED NATURE OF SPARES

(To be given in separate sealed cover)

Due date for opening: The due date will be intimated to successful bidders after opening of Part-I i.e. Techno-commercial bid.

Name of the bidder _____

S. No.	Description	UOM	Unit Basic Price (Rs.)	IGST (Rs.)	SGST (Rs.)	CGST (Rs.)	Freight, Insurance and any other delivery charges up-to destination (Rs.)	Other Charges, if any (Rs.)	Total Landed Cost at destination (Rs.)
1	Head Well with Lateral Wall Tip R .H. (Part No. 001.475.38.298 00M)	Nos.							
2	Head Well with Lateral Wall Tip L.H. (Part No. 002.475.38.297 00M)	Nos.							
3	Plate Sail Hard / Tiscral, 25 MM X 1250MM X 3000 MM, 25MM Thick	MT							
4	"U" Clamp with 2 Nut & M.S. Plate L- 125MM, Ø12M Part No. L-125, Ø12MM (as per enclosed drawing RSMM/JKT/IBP-LGO/2014/U1001	Nos.							
5	Head Valve Set (Left and Right) Complete assembly consist of two head valve Left right with all SS 316 hardwares (MOC-Hardox-450)	Set							

Note:

1. Please quote the duties and taxes as per applicable rate (on the date of opening of Part I of the offer).
2. Price shall remain firm and fixed during the period of contract except price variation formula.
3. Escalation/de-escalation will be provided /passed on to RSMML, as the case may be in respect of Statutory Duties and Taxes subject to production of documentary proof.
4. If any particular item is not applicable, please write "Not applicable".
5. **You may please indicate item wise price break-up/justification of your quote along with price bid, if required.**
6. Please enclosed separate sheet in given format, if required.

Place & Date

Signature of Tenderer with official stamps